

MILLENNIUM CATALOGUE

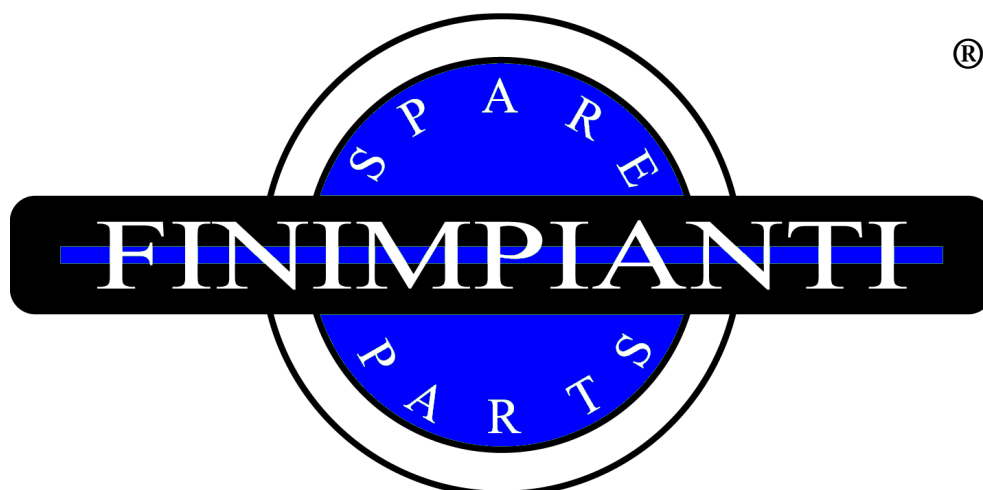

RICAMBI ALTERNATIVI PER
MOTOFALCIATRICI BCS

NON ORIGINAL PARTS FOR
BCS MOTOR MOWER

Questo catalogo contiene dati ed informazioni provenienti dalla pluriennale esperienza di Finimpianti. Tuttavia non possiamo assumere alcuna responsabilità per eventuali dati errati od incompleti.

Tutti i dati e le informazioni contenute nel presente catalogo sono fornite a puro scopo informativo e senza responsabilità e non potranno dare adito ad alcuna forma di risarcimento.

Visto il continuo sviluppo dei nostri prodotti, Finimpianti si riserva il diritto di apportare modifiche senza preavviso.

Denominazioni, numeri e codici originali sono riportati a puro titolo di riferimento.

All the information and data contained in this catalogue came from the long Finimpianti experience. Nevertheless we can not assume any responsibility for possible mistakes.

All the information and data contained in this catalogue are provide "as is" without any representation or warranty express or implied. Under no circumstances whatsoever shall Finimpianti be liable for any damages whatsoever arising out of the use of the information and data contained in this catalogue.

Finimpianti does not warrant the accuracy or completeness of the materials and content contained in this catalogue and reserves the right to correct any errors or omissions at any time without notice and without obligation to the users of this catalogue.

OEM names, codes and part numbers, used in this catalogue, are for reference only.

B.C.S. 622

**BARRA
FALCIANTE**

**CUTTING
MECHANISM**

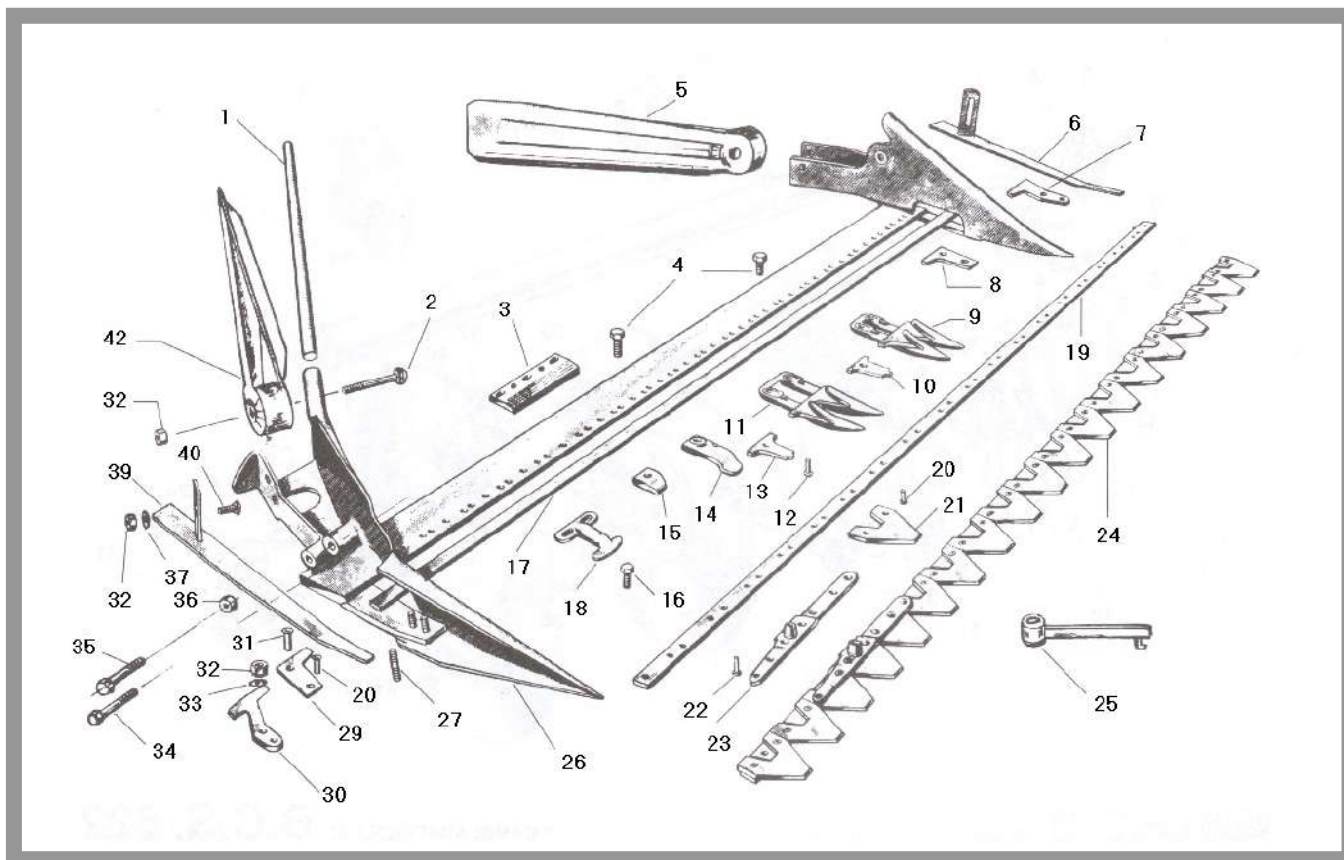

POS.		Adattabile a:	DESCRIZIONE
		Suitable for:	DESCRIPTION
1		580.02463	Bastone lungo
1		580.02536	Bastone corto
2		580.20205	Vite speciale
3	FIN0685BCS	563.20685	Premilama posteriore
4		311.11213	Vite TE M10 x 30 UNI 5739 - 5S
5	FIN0657BCS	592.20657	Asse andana sinistra
6	FIN2898BCS	590.02898	Slitta scarpa sinistra
7	FIN2829BCS	561.02829	Premilama laterale sinistro
8	FIN2848BCS	523.02848	Piastrina scarpa sinistra semifitta
9	FIN7622BCS	590.27622	Dente doppio fitto
10	FIN2355BCS	580.02355	Piastrina per dente fitto
11	FIN7624BCS	590.27624	Dente doppio semifitto
12	FIN2533BCS	331.12533	Ribattino TSV 5,3 x 25
13	FIN2477BCS	580.02477	Piastrina per dente semifitto
14	FIN2823BCS	523.02823	Premilama ad un foro
15	FIN2828BCS	525.02828	Premistriscia
16		311.11212	Vite TE M10 x 25 UNI 5739 - 5S

Ricambi alternativi per motofalciatrici B.C.S. . I codici originali utilizzati in questo catalogo servono unicamente come referenza.

Non original parts suitable for B.C.S. motor mower. Manufacturers part numbers used in this catalogue, are for reference purposes only.

B.C.S. 622**BARRA
FALCIANTE****CUTTING
MECHANISM**

POS.		Adattabile a:	DESCRIZIONE
		Suitable for:	DESCRIPTION
17	FIN0701BCS	563.20701	Asta consumo 13 sezioni (cm.100)
17	FIN3574BCS	563.43574	Asta consumo 15 sezioni (cm.110)
17	FIN3555BCS	563.43555	Asta consumo 17 sezioni (cm.127)
17	FIN0709BCS	563.02709	Asta consumo 19 sezioni (cm.140)
17	FIN0704BCS	563.20704	Asta consumo 21 sezioni (cm.160)
18	FIN2824BCS	523.02824	Premilama a T
19	FIN0706BCS	580.20706	Asta forata 13 sezioni (cm.100)
19	FIN0707BCS	580.20707	Asta forata 15 sezioni (cm.110)
19	FIN0708BCS	580.20708	Asta forata 17 sezioni (cm.127)
19	FIN2465BCS	580.02465	Asta forata 19 sezioni (cm.140)
19	FIN2709BCS	580.20709	Asta forata 21 sezioni (cm.160)
20	FIN5230BCS	331.12530	Ribattino TSV 5,3 x 14
21	FIN4664BCS	580.02466	Sezione rigata
21	FIN2986BCS	580.02986	Sezione liscia
22	FIN2532BCS	331.12532	Ribattino TSV 5,3 x 20
23	FIN0494BCS	523.20494	Testa di lama
24	FIN0712BCS	590.20712	Lama rigata 13 sezioni (cm. 90)
24	FIN0714BCS	590.20714	Lama rigata 15 sezioni (cm. 110)
24	FIN0716BCS	590.20716	Lama rigata 17 sezioni (cm. 127)
24	FIN0688BCS	590.20688	Lama rigata 19 sezioni (cm. 140)
24	FIN0718BCS	590.20718	Lama rigata 21 sezioni (cm. 160)
24	FIN7525BCS	590.27525	Lama rigata 19 sezioni montata sotto serie 268
24	FIN7530BCS	590.27530	Lama rigata 21 sezioni montata sotto serie 268
25	FIN0491BCS	590.20491	Chiave
26	FIN1132BCS	590.21132	Spranga 15 sezioni
26	FIN1133BCS	590.21133	Spranga 17 sezioni
26	FIN1134BCS	590.21134	Spranga 19 sezioni
26	FIN1135BCS	590.21135	Spranga 21 sezioni
27		313.11101	Prigioniero M10 x 30 x 10 x 16 - 5S
29	FIN2847BCS	523.02847	Piastra scarpa destra semifitta
30	FIN0885BCS	523.02825	Premilama laterale destro
31	FIN2531BCS	331.12531	Ribattino TSV 5,3 x 18
32		312.11100	Dado M10 - UNI 5588 - 5S
33		314.23105	Rosetta elastica B 30,5 - DIN 137
34		311.13212	Vite TE M10 x 95 - UNI 5739 - 10K
35		311.13210	Vite TE M10 x 85 - UNI 5739 - 10K
36		312.41100	Dado autobloccante M10
37		314.11105	Rosetta piana 10,5 - UNI 1733 Acc.
39	FIN2897BCS	590.02897	Slitta scarpa destra
40		311.21600	Vite M10 x 25 TTQ - UNI 883 - 5S
42	FIN0655BCS	592.20655	Asse andana destra

B.C.S. 622

BRACCI-ALBERO
SCATOLA
OSCILLANTE

ARMS-SHAFT
OSCILLATING
BOX

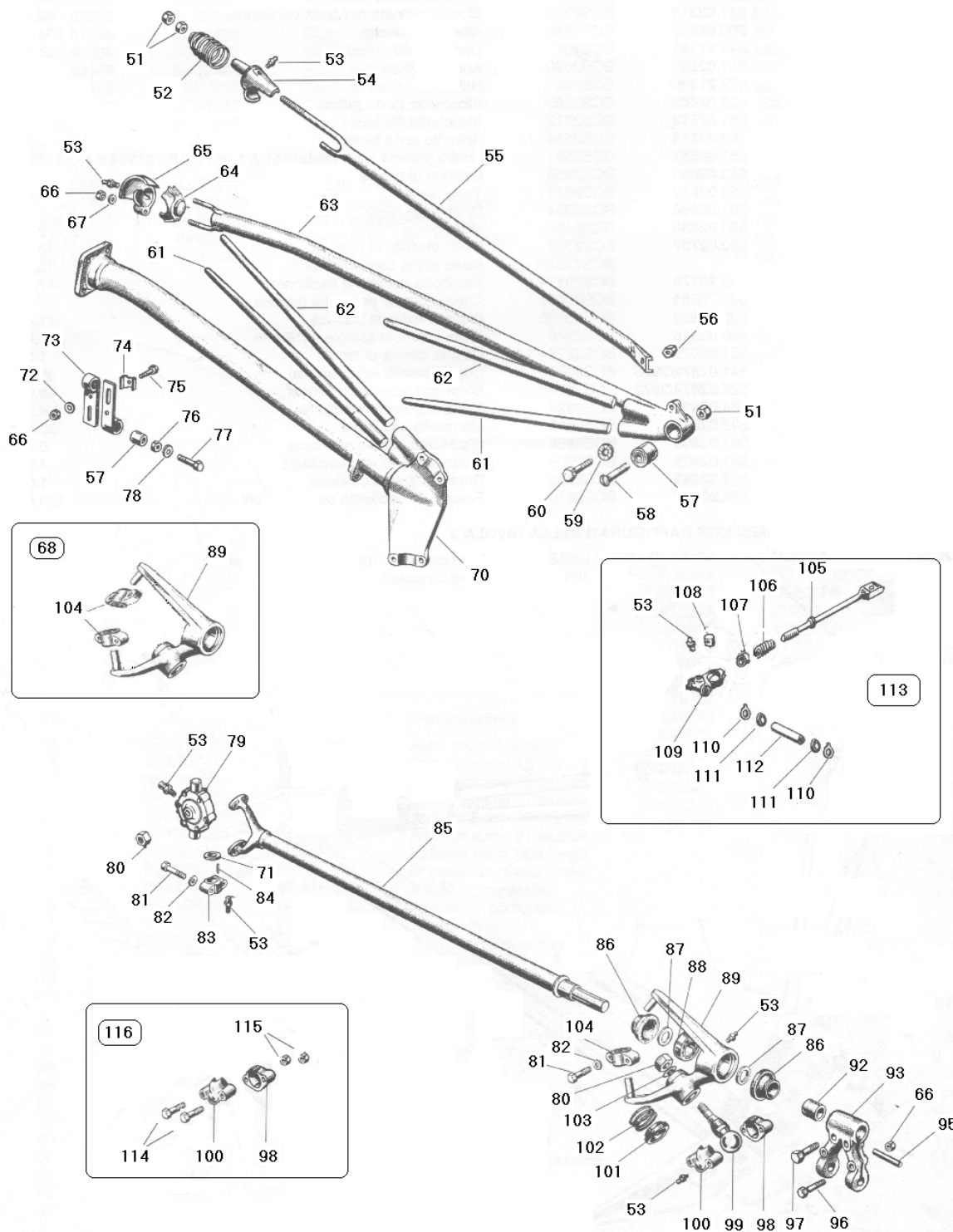

Ricambi alternativi per motofalciatrici B.C.S. . I codici originali utilizzati in questo catalogo servono unicamente come referenza.

Non original parts suitable for B.C.S. motor mower. Manufacturers part numbers used in this catalogue, are for reference purposes only.







B.C.S. 622**BRACCI-ALBERO
SCATOLA
OSCILLANTE****ARMS-SHAFT
OSCILLATING
BOX**

POS.		Adattabile a:	DESCRIZIONE
		Suitable for:	DESCRIPTION
51		312.31140	Dado basso M14
52	FIN0137BCS	580.20137	Molla sostegno braccio sx per 1,40 - 1,55
52	FIN0138BCS	580.20138	Molla sostegno braccio dx per 0,90 - 1,10 - 1,27
53	FIN0001BCS	300.00001	Ingrassatore M10
54	FIN2850BCS	512.02850	Appoggio molla
55	FIN0672BCS	590.20672	Tirante sx. per 0,90 - 1,10 - 1,27
55	FIN1144BCS	590.21144	Tirante sx. per 1,55 ponte normale
55	FIN1148BCS	590.21148	Tirante sx. per 1,40 - 1,55 ponte lungo
56		312.11100	Dado M10 - UNI 5588 - 5S
57		300.10140	Silentbloc 14x30x25x28
58		561.02390	Vite speciale
59		314.31105	Rosetta dentellata AZ 10,5 - DIN 6798
60		311.12212	Vite TE M10 x 35 - UNI 5739-8G
61		580.02526	Bastone corto
62		580.02463	Bastone lungo
63	FIN0252BCS	592.90252	Braccio sx. per 0,90 - 1,10 - 1,27 (ruote 4,50-19")
63	FIN0253BCS	592.90253	Braccio sx. per 0,90 - 1,10 - 1,27 (ruote 5,00-14")
63	FIN0254BCS	592.90254	Braccio sx. per 1,40 - 1,55 ponte lungo (ruote 5,00-14"/6,00-16")
63	FIN0255BCS	592.90255	Braccio sx. per 1,40 - 1,55 ponte lungo (ruote 4,50-19")
63	FIN0256BCS	592.90256	Braccio sx. per 1,40 - 1,55 ponte normale (ruote 5,00-14"/6,00-16")
63	FIN0257BCS	592.90257	Braccio sx. per 1,40 - 1,55 ponte normale (ruote 4,50-19")
64	FIN0248BCS	541.20248	Calotta
65	FIN0244BCS	532.20244	Coperchio Calotta
66		312.11080	Dado M8 - UNI 5588-5S
67		314.23084	Rosetta elastica B 8,4 - DIN 137
68	FIN0060BCS	592.90060	Scatola oscillante con manicotti
70	FIN0110BCS	590.20110	Braccio destro
71	FIN2690BCS	551.02690	Anello tenuta blocchetto oscillante
72		314.11084	Rosetta piana 8,4 - UNI 1733 Acc.
73	FIN0114BCS	561.20114	Registro spranga per ruote 19"
74	FIN2884BCS	561.02884	Lastrina per registro
75		311.11153	Vite TE M 8 x 25 - UNI 5739-5S
76		312.11140	Dado M14 - UNI 5588-5S
77		311.11331	Vite TE M 14 x 50 - UNI 5739-5S
78		314.11150	Rosetta piana 15 - UNI 1733 Acc.
79	FIN2669BCS	590.02669	Testa oscillante
80	FIN1181BCS	312.11181	Dado M18 x 1,5 con calotta
81		311.12214	Vite TE M10 x 45 - UNI 5739-8G
82		314.23105	Rosetta elastica B 10,5 - DIN 137
83	FIN2885BCS	522.02885	Blocchetto rullini
84	FIN1300BCS	379.21300	Rullino RN 3 X 15,8
85	FIN2849BCS	590.02849	Albero oscillante
86	FIN2908BCS	551.02908	Paraolio scatola oscillante
87		563.02892	Rosetta albero oscillante



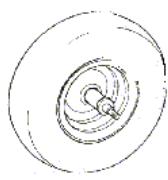

B.C.S. 622	BRACCI-ALBERO SCATOLA OSCILLANTE	ARMS-SHAFT OSCILLATING BOX	
-------------------	---	---	--

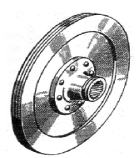
POS.		Adattabile a:	DESCRIZIONE
		Suitable for:	DESCRIPTION
88		371.31300	Cuscinetto 30x62x20 - 2206 oscillante
89	FIN2870BCS	512.02870	Scatola oscillante nuda
92	FIN2868BCS	561.02868	Distanziale albero oscillante
93	FIN2815BCS	523.02815	Manovella oscillante
95	FIN2424BCS	564.02424	Spina per biella
96		311.12154	Vite TE M8 X 40 -UNI 5739-8G
97		311.00103	Vite M12 X 1,5 x 35 -UNI 188-8G
98		541.02872	Semiguscio in bronzo
99	FIN2874BCS	522.02874	Sfera con cono
100		541.02905	Semiguscio in bronzo
101	FIN2875BCS	551.02875	Calotta sferica di tenuta
102	FIN2946BCS	580.02946	Molla di tenuta
103	FIN3185BCS	314.23185	Rosetta elastica B 19 - DIN 137
104	FIN0174BCS	592.20174	Manicotto scatola oscillante
105	FIN2707BCS	590.02707	Biella elastica in ferro
106	FIN2430BCS	580.02430	Molla
107	FIN2394BCS	561.02394	Distanziale biella
108	FIN2512BCS	561.02512	Blocchetto per biella
109	FIN2817BCS	590.02817	Testa biella
110	FIN2856BCS	563.02856	Lastrina di tenuta
111	FIN0581BCS	551.02581	Anello in gomma per testa biella
112	FIN2514BCS	562.02514	Spinotto per testa biella
113	FIN2700BCS		Biella Completa
114			Vite
115			Dado
116	FIN3008BCS		Coppia semigusci in bronzo con viti e bulloni

B.C.S.	ARTICOLI VARI	VARIOUS ITEMS	
---------------	----------------------	----------------------	--

ARTICOLO		Adattabile a:	DESCRIZIONE
ITEM		Suitable for:	DESCRIPTION
	FIN4518BCS	391.14591	Copertura 4,50 x 19"
	FIN4519BCS	394.14519	Camera d'aria 4,50 x 19"
	FIN3000BCS	590.03000	Ruotino completo
	FIN0347BCS	580.20347	Filo e guaina gas
	FIN0580BCS	580.02580	Filo e guaina gas lungo
	FIN0331BCS	580.20331	Filo e guaina frizione
	FIN2426BCS	590.02426	Disco frizione

B.C.S.	ARTICOLI VARI	VARIOUS ITEMS	
--------	---------------	---------------	--

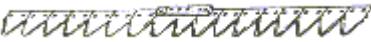
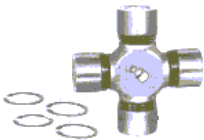
ARTICOLO ITEM		Adattabile a: Suitable for:	DESCRIZIONE DESCRIPTION
	FIN0269BCS	590.02690	Sedile in lamiera
	FIN0538BCS		Manopola gas in gomma
	FIN2538BCS		Manettino gas in plastica
	FIN35530BCS	590.43553	Lama 17 sezioni centrale
	FINBYPY441	BY PY 4.41	Crociera dim. 27 X 74,6
	FINBYPY641	BY PY 6.41	Crociera dim. 30,2 X 92

FINIMPIANTI S.r.l.

Via Aldo Moro,9 - 10080 Oglianico (TORINO) - ITALY

Tel. + 39 0124 470670 - Fax + 39 0124 470686

www.finimpianti.it e-mail: info@finimpianti.it